

# ZENITH RADIO CORPORATION

## MODEL SA55

RIGHT CHANNEL

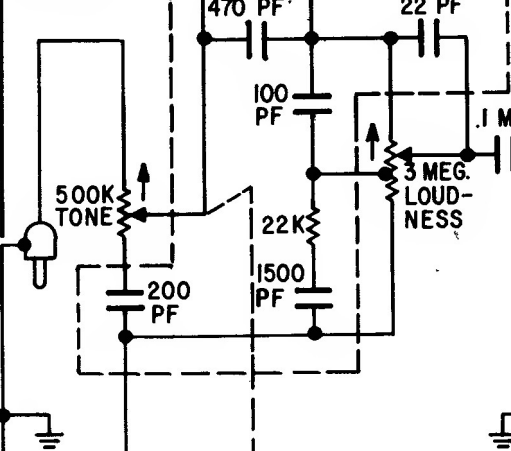

2N2926 DRIVER

2N301 OUTPUT

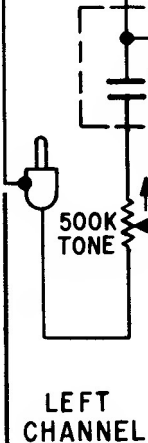
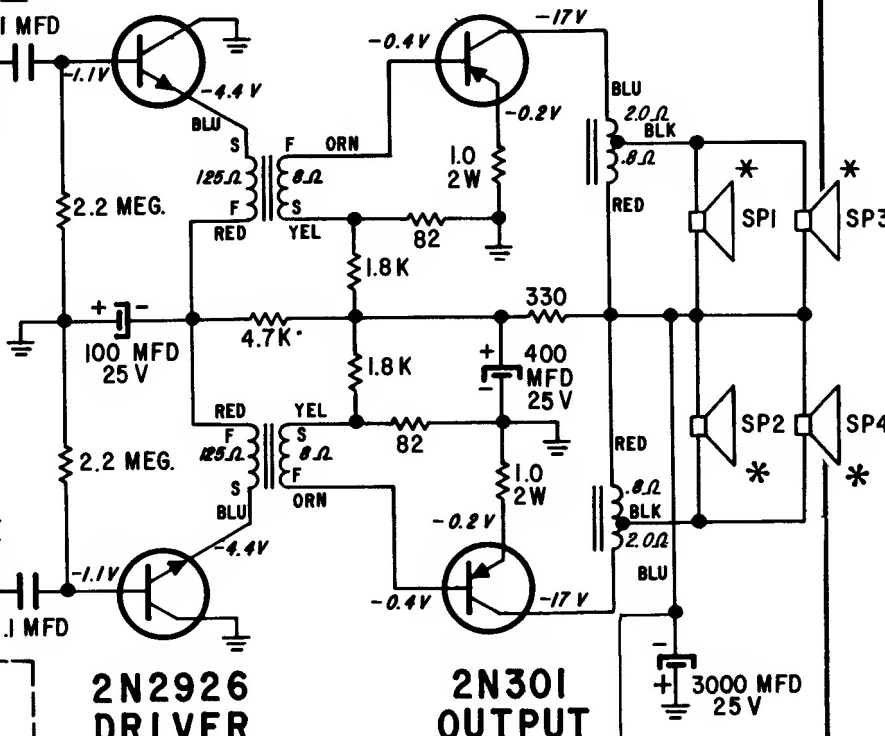

2N2926 DRIVER

2N301 OUTPUT

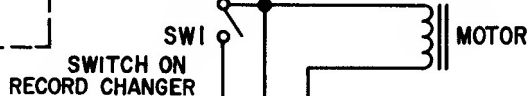

CHANGER MASS

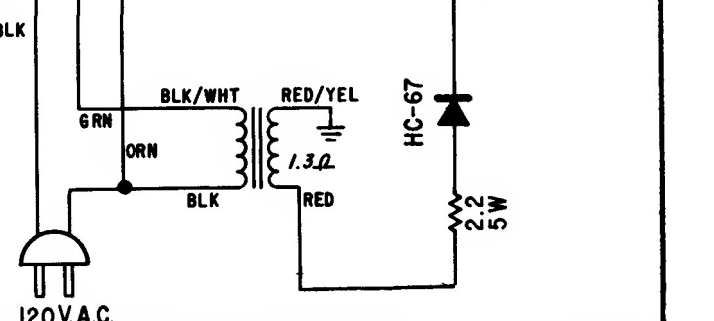
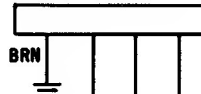
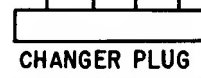

**NOTES:**

1. RESISTORS ARE 1/2 WATT ±10% TOLERANCE UNLESS OTHERWISE SPECIFIED.
2. OBSERVE POLARITIES OF CAPACITORS.
3. \* INDICATES RED DOT ON SPEAKERS.

**SPECIFICATIONS**

Power Supply.....	120V AC 60 Cycles
Current Consumption.....	27 Watts
Peak Power Output.....	4 Watts per channel
Speakers.....	Two 4" PM, 16 ohm V.C.
	.....Two 5 1/4" PM, 16 ohm V.C.